

Analysis of importance of road networks exposed to natural hazards

Jean-Marc Tacnet
 Irstea, UR ETGR
 2 rue de la papeterie-B.P. 76
 F-38402 St-Martin-d'Hères, France
 jean-marc.tacnet@cemagref.fr

Eric Mermet
 IGN, COGIT; Université Paris-Est
 73, avenue de Paris
 F-94160 Saint-Mandé, France
 eric.mermet@ign.fr

Somsakun Maneerat
 Irstea, UR ETGR
 2 rue de la papeterie-B.P. 76
 F-38402 St-Martin-d'Hères Cedex, France

Abstract

Roads in mountains areas are exposed to natural hazards such as snow avalanches, torrent floods and rockfalls. Risk depends both on hazard, direct and indirect vulnerability. In case of roads, the indirect vulnerability relates to the consequences of road closures which is rarely assessed. The criticality of these closures depends on the importance of road sections. A new methodology is proposed in the context of natural risks management in mountains. Based on structural networks analysis, it aims to assess the accessibility level of mountain territories and to identify critical roads sections depending both on their exposure to phenomena but also on the importance of roads on economic, social, environmental contexts. The structural network analysis allows to describe how far the network properties conditions the accessibility from one point to another. This approach is combined to multicriteria decision making to assess importance according to economic, social or human factors but also fragility, resilience or risk sensitivity on road sections.

Keywords: road management, mountains, natural hazards, criticality analysis, geographic information systems, structural network analysis

1 Introduction

1.1 Decision context and needs for decision support systems

In mountains areas, rapid mass movement hazards such as snow avalanches put humans, property, infrastructures and also road networks at risk with dramatic consequences. Risk is classically derived from hazard and vulnerability assessments. For natural phenomena in mountains, such as snow avalanches, debris-flows or rockfalls, the hazard is a combination of intensity (speed, deposition height, volume of avalanches, blocks, etc.) and frequency. A natural phenomenon induces a risk only if it may cause any kind of human, material, economic, social and environmental losses. In industrial contexts, the severity is used as a combination of intensity and potential consequences (vulnerability and losses)(figure 1). In the dependability analysis approaches, criticality also introduces the detectability of a potential failure [11]. The level of severity will depend on the importance of the road for all the possible consequences.

The vulnerability is a combination of a potential of damage, its associated costs and the exposure of persons, goods, infrastructures, vehicles. This vulnerability which relates to consequences of natural phenomena, can be decomposed into direct and indirect vulnerability. Direct vulnerability corresponds to physical damage directly linked to the effects of phenomena such as physical injuries on people, damage on infrastructures (rupture, debris-flows, avalanches, deposition, rockfalls impact, etc.).The indirect vulnerability corresponds to the remote consequences of

Figure 1: Concept of risks in natural hazards and industrial contexts.

Natural hazards context

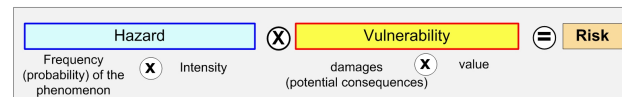

Industrial context

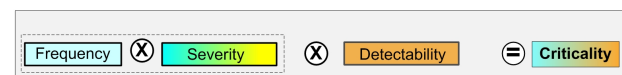
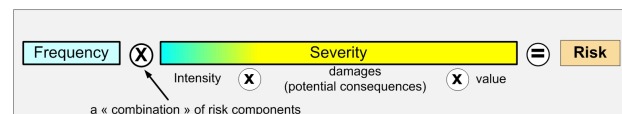

Source: [15].

a feared event such as an avalanche, a debris-flows.

Decision support systems are needed to take decisions at each stage of the risk management circle with its classical steps of crisis management, recovery, prevention and mitigation (figure 2). Direct (and mainly material) vulnerability is classically assessed in any risk management measures such as risk prevention plans (P.P.R.). Existing measures are mainly designed and focused on permanently occupied areas and buildings (houses, schools, factories) but not for roads. The assessment of vulnerability, importance and criticality is nevertheless necessary to identify the

road sections where prevention measures against risks must be planned, implemented, reinforced.

Figure 2: Different steps of risk management.

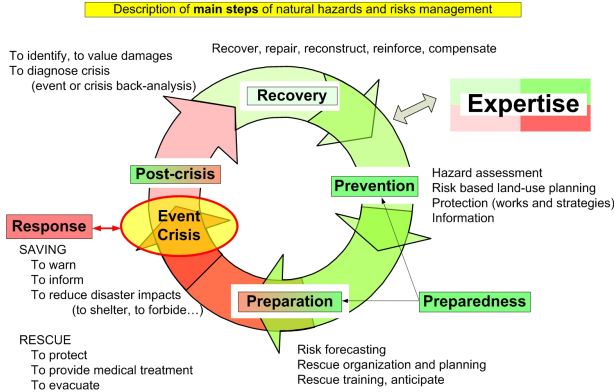

Source: [14].

1.2 Functions of roads: direct and indirect vulnerability

Road networks are essential for economic, social, environmental and security reasons and can therefore be considered as part of the critical networks that can be ranged according to the consequences of their disruptions (figure 3).

Figure 3: Cross-relations between the vital networks.

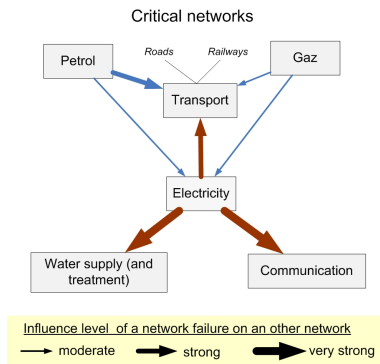

Our approach is based on the functional analysis of roads : a road has to connect geographic areas and allow transport of persons and goods in good conditions of duration and security. Failures can concern either the users (vehicles, passengers, transported goods), the support infrastructures (road, security equipments, bridges, etc.) and also the transport function (connectivity, accessibility of points connected to each other by the road). A road hit by natural phenomena induces therefore two level of consequences: on one hand, human and vehicles can be respectively injured or destroyed and on the other hand, the traffic disruption can have severe indirect consequences: those closures of roads induce economic consequences (workers transportation, supply chain disruption for factories, commercial units and stores, etc.), social consequences (loss of access to schools,

universities...) or security related consequences (loss of access to rescue, fire and police departments) which are difficult to assess. Some economic approaches have been proposed to evaluate the indirect costs of road use considering costs corresponding to accidents, noise, air pollution, climate change, nature, urban effects and upstream process [4, 1]. However, the assessment of both direct and indirect vulnerability of roads remains an important issue.

1.3 Principles of our methodology based on structural analysis

Our methodology aims to assess road vulnerability, including direct and indirect effects of natural phenomena. The indirect vulnerability level is directly linked to the importance of the road. Structural network analysis and multicriteria decision analysis are used to consider the remote features of the road closures and to assess their relative importance.

Ease to go from one point to another on roads depends on the characteristics of the road network. This includes both its physical properties of the roads (width, slope, number of lines of different roads) and its structure (number of ramifications, mesh structure). A ski resort served by an unique steep access road, exposed to avalanches, torrent floods and rockfalls will be less accessible than a town connected to motorways, several departmental roads in a valley. A road can therefore be more or less important and exposed to constraints. This importance depends on the nature of traffic flow (cars, trucks, coaches), the range of the main displacement (local, regional, national roads) and the consequences of road traffic interruption according to economic, industrial activities but also safety factors such as hospitals, fire rescue department accessibility, etc..

Structural network analysis is a technique that allows to describe how far the network properties conditions relational potentials of the network. The measurement of these potentials depends on the paths, often the shortest, that the network offers to connect two sites. Two main indicators are used in structural network analysis: 1. the centrality indicator measures the level up to which a road is used to reach any point ; 2. the average distance is an indicator to show how it is either difficult or easy to reach a point on the network. A good cross-use of these two measures can highlight network performance induced by the manner in which the vertices are connected.

This paper presents a methodology and an application to a road network located in France : Maurienne valley road network is exposed to natural hazards in mountains (snow avalanches, debris-flows and rockfalls). The principle is to combine structural properties analysis of road networks and multicriteria decision making to assess both hazard, vulnerability level and importance of roads sections. This paper which focuses on the principles of structural analysis and its implementation in our thematic context, is organized as follows. The first section is a general introduction of the context. Section 2 describes backgrounds of structural properties of networks and multicriteria decision making. The third section explains the methodology that we finally used. Section 4 describes some application results to our case study and the last section proposes a discussion and conclusion but also perspectives of this work.

2 Backgrounds

2.1 Structural properties of networks

Exploring the structural properties of transportation networks lies on several domains: graph theory for modeling and using different data structures, computer science to build efficient graph analysis algorithms or conceptual models and finally geovisualization to observe the behavior or phenomena on a network [3]. Structural properties of the networks can be analyzed using techniques derived from graph theory [5]. These techniques, based on crossing edges and vertices attributes from different maps layers, can reveal network features like strengths and weaknesses on its components. To do this, we developed a generic tool called *GeoGraphLab* [9] which lies on a four parameters models (figure 4):

- Space is constituted of a set of Origin-Destination (OD) relations on the network (figure 8). It is the set of definition for measure calculus;
- Measure is a mathematical property which synthesizes information collected on OD relations;
- View is a graphical representation of the network which permits the variation of levels of details by vertices aggregation [6];
- Legend allows better assessing results displayed by operating variation on the number of boxes (classification) and colors (symbolization).

Figure 4: Simplified UML model for the kernel of structural properties exploration in *GeoGraphLab*.

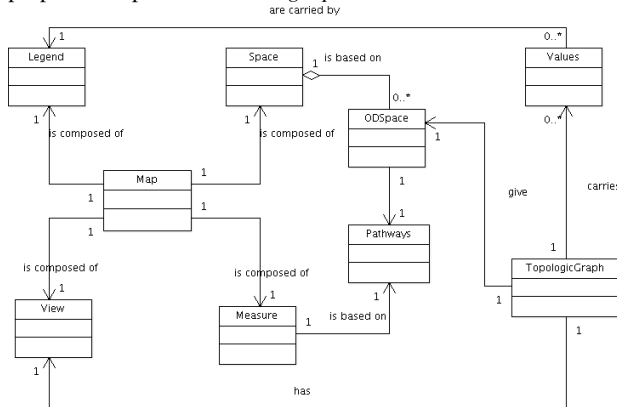

Association of these parameters produces what we called an exploratory map. The creation of a map for each measure corresponds to an indicator calculation. The indicators can be picked up in the classical library of the existing ones such as betweenness centrality, proximity centrality, average or maximum distance, proximal or distal radius, etc. which are often based on OD shortest paths. The indicators may also be based on other logical moves (random walk, user defined, etc.). Attributes of vertices and edges considered for the calculation can be strictly structural (distance or travel time on a road section but also track number, slope¹) or can also be thematic (population, traffic flow, size of ski resorts or numbers of beds, etc.).

¹resulting from road Layer from the BDTopo - IGN

In comparison with existing commercial applications dedicated to structural networks analysis, the *GeoGraphLab* application provides the original feature to interact directly with data through a graphical language. In the latter, it is possible to combine maps, graphically represented by what we call “block-map”, and so indicator measures, in a user interface to obtain new indicators [10] (figure 5).

Figure 5: An example of cross-combination of different block maps in *GeoGraphLab* graphical language interface.

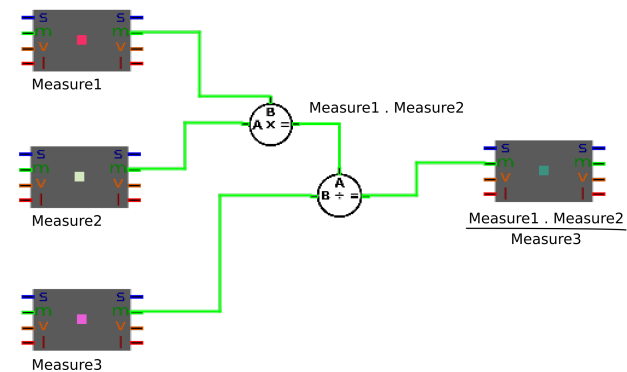

The advantages of this graphical method are :

- to allow network exploration with a tree method, where each measure is a leaf that be crossed with others,
- to facilitate the data manipulation, crossing and information extraction.

2.2 Multicriteria decision making

In difficult and complex contexts, decisions often result from heterogeneous criteria on which decision makers express their preferences. Multicriteria decision problems can be described by either problems of choosing, sorting or ranking alternatives or solutions [12]. In the context of road management, these alternatives are, as examples, either decisions to close roads, to limit traffic (speed reduction, night closure ...). Alternatives can also be road sections if the decision to take concerns the identification of the most exposed and dangerous points on the road. The identification of the decision problem and the alternatives to be chosen, sorted is therefore an essential preliminary work (figure 6)[14]. Different methods such as AHP (Analytic Hierarchy Process)[13] or any other method are used afterwards to evaluate importance, exposure, vulnerability levels of roads that will be used as constraints in the structural analysis (figure 7).

3 Methodology

The methodology is based on two steps. The first step characterizes the initial state of socio-economic factors across the territories. The second one translates them into structural indicators (linked to importance) of each road section using both network structural properties and constraints issued from a multicriteria analysis of natural hazards.

Step 1: Evaluation of the initial state of economic factors

A first G.I.S. analysis of the economic, social and environmental

Figure 6: Methodological steps and actors of a multicriteria approach.

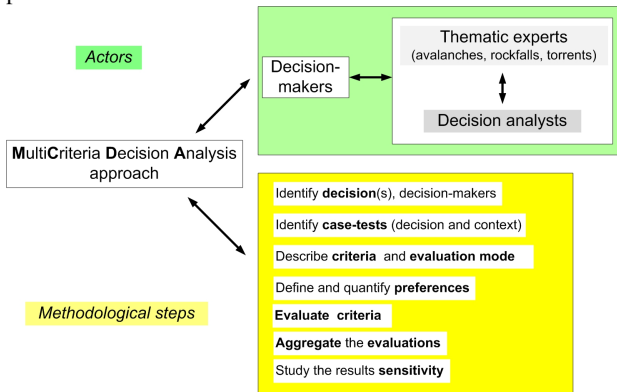
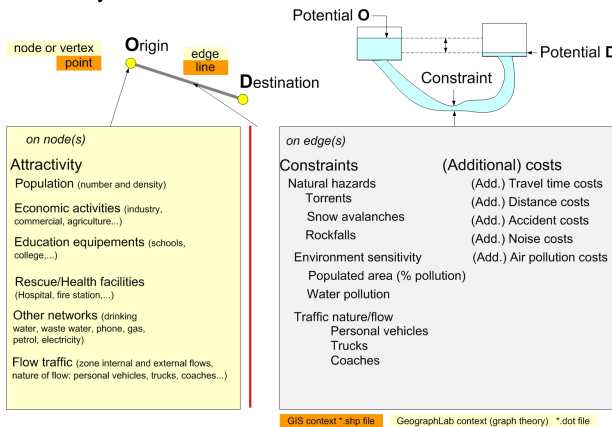

Figure 7: Thematic indicators corresponding to economic, social, environmental ... contexts are derived into constraints and attractivity indexes.



context is done in order to identify the location and importance of the main economic centers, the status of road networks, etc. [8] (figure 7).

Step 2 : Evaluation of the structural properties

The parameters used for the evaluation of the structural properties come from the road layer on the BDTopo² : euclidean length between two vertices, length or width of road section, slope, sinuosity, number of tracks or one-way tracks. A new specific development has been done on *GeoGraphLab* software in order to allow to consider thematic layers above the structural analysis. So we can now add any incoming data such as city population, economic, number of beds in a ski resort, natural hazards features, etc. Then *GeoGraphLab* helps to easily manipulate, cross and compute structural measures on data supported by the graphical language to visually control all possible combinations of data.

In this way, incoming data are seen as attributes on edges (road sections) and on intersections (vertices). That's all what *GeoGraphLab* needs to compute relational indicators. We

²vector database provided by IGN³

Figure 8: Betweenness centrality and average distance on the main roads network in France.

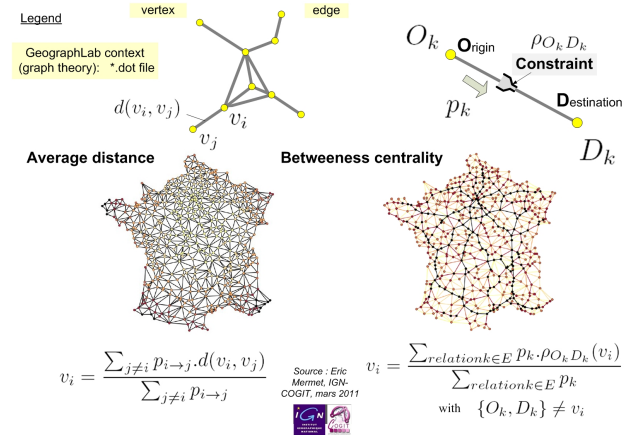

choose to use two simple measures : average distance and betweenness centrality. For each vertex (v_i) and/or each edge (e_i), computational principle for these two indicators consists in evaluating the path $p_{i \rightarrow j}$ and its distance on network $d(v_i, v_j)$, the weight p_k of the OD-relationship and then counting the number of paths $\rho_{O_k D_k}$ from O to D (see equations in figure 8). Using these two measures has the advantages to clearly highlight areas an phenomena on the network. Moreover, units of these measures are easily intelligible (number or length of paths), and representative to be interpret in a correct way.

Paths are computed on any attributes of network component. This means that it is possible to get as result a betweenness centrality based on other paths than the shortest (time or distance). If we consider the safest path as an input the indicator (Dijkstra algorithm has to find a lower bound in utility function that can be based on hazard, vulnerability, frequency, severity or detectability of risk), the mapping result will show areas on the network where the risk is lower.

If these maps are combined by crossing block-maps corresponding to the different indicators in the graphical user interface, new indicators are created on the basis of structural and functional aspects of the studied network. Various operators (basic mathematical functions or other functions) can be used in these crossing operations. Additional information like fragility, resilience or sensitivity of road sections (figure 9) are thus revealed.

Two different methodologies (figure 10) can be used to combine the initial criteria using multicriteria decision analysis and the results of the structural analysis. The first methodology is called *ASTA* (Assess the Structural properties of network first Then Aggregate) and the other one is called *ACAS* (Aggregate Criteria of the network first then Assess Structural properties).

Figure 9: Principles of transformation of thematic features into structural properties indicators using *GeographLab*.

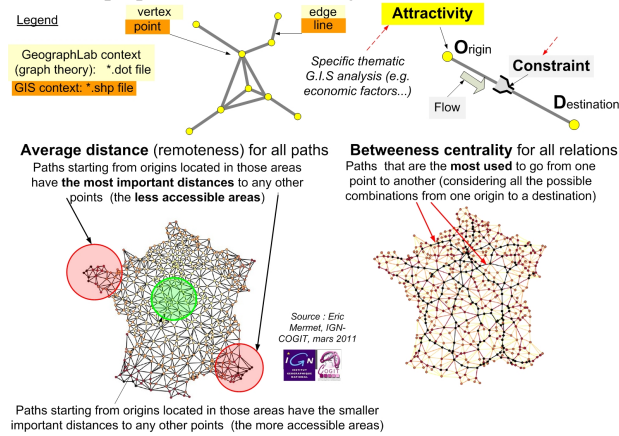
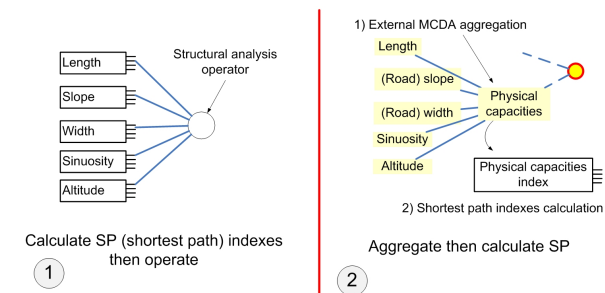

Figure 10: Strategies for structural properties assessment : example of geometric and topographic road features.

Two strategies for importance assessment using MCDA and network structural analysis



4 Applications

An application of this methodology has been done in the Maurienne Valley (Savoie, France)[8]. Economic data coming from INSEE databases [7] are analyzed in order to identify and locate main activities (figure 11). Those data are used afterwards in order to determine attractivity indexes.

Data related to topographic, geometric and traffic features of roads [2] and natural hazards information resulting from existing ONF/RTM events database (figure 12) or specific multicriteria decision model [14, 15] are used as constraints in the structural analysis.

The results are obtained for the road network for each domain of activity. They correspond to the two main indicators described below and denoted as betweenness centrality and average distance. As an example, the figure 13 shows the importance of roads calculated by *GeographLab* and based both on features of road network and on economic attractivity of vertices in the tertiary sector of economy (services).

5 Conclusion - Discussion

This paper proposes an original methodology to analyze the indirect vulnerability of roads exposed to natural hazards combining

Figure 11: Main economic activities in Maurienne Valley, Savoie, France.

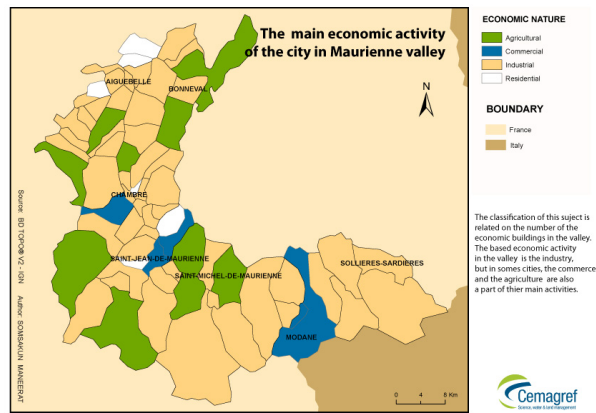

Figure 12: Historical torrential events in relation with roads in Maurienne Valley, Savoie, France.

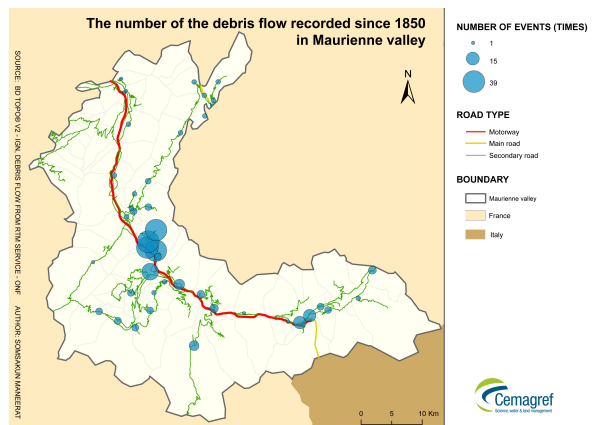
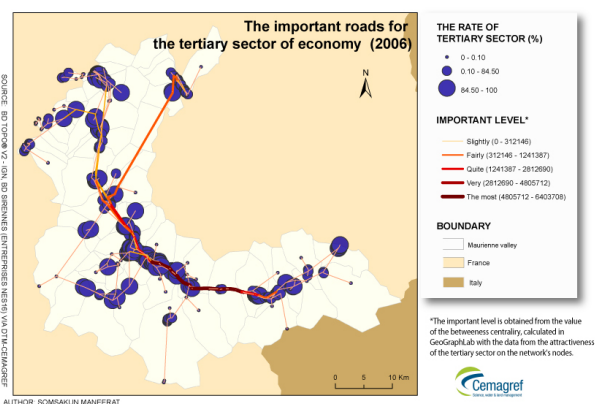

Figure 13: Example of structural analysis with thematic data to assess importance of roads.



using network structural properties analysis. The indicators provide information about the global accessibility of any point of the network and the importance of each road section since the structural analysis explore all the possible paths from one point to another.

The development of a new specific methodology and its application to a practical case study dedicated to road network is the first major input of this work. The *GeographLab* software has been extended in order to import thematic layers from G.I.S. applications. This shows the feasibility and the interest of such an approach in order to analyze the importance and criticality of roads sections exposed to natural hazards considered as constraints. An open issue concerns the order of use of structural properties indicators and multicriteria analysis results: comparison have still to be analysed to compare strategies (figure 10).

This first application also showed that the initial geographic, economic, environmental data processing is an essential part but time-consuming of the global methodology. The thematic approach of economic and social factors can still be improved in collaboration with economy, geography specialists. The actual data analysis may be somewhat considered as prototypes. The case study of the Maurienne Valley relates to a very simple network structure. Therefore, the identification of critical sections is not spectacular due to the linear structure of network (in opposition to a high meshed structure). However, our developments remain interesting for global network analysis with several interconnections and assessment of the accessibility level of roads on wide geographic areas. Perspectives of this work concern both improvement of the thematic analysis and new developments of the application. *GeographLab* development is still under progress : new features corresponding to the easy importation of GIS layers, to the results analysis, the connection with multicriteria decision plug-in are planned in future releases of the *GeographLab* environment. With these news features, the *GeographLab* application will be mature enough to be soon open-source released.

Acknowledgements

These developments are partially founded by the *PARAMOUNT* Project (<http://www.paramount-project.eu/>) of the European InterReg Alpine Space program.



References

- [1] Marcel Boiteux and Luc Baumstark. Transports : choix des investissements et coût des nuisances. Technical report, République Française, Premier Ministre, Commissariat Général du Plan, France, juin 2001.
- [2] CG73. Conseil général de la savoie - bilan des trafics et circulation hivernale année 2010, 2011.
- [3] J. Dykes, A-M. MacEachren, and M.-J. Kraak. *Exploring Geovisualization*. Elsevier, 2005.
- [4] EEA. Term 2002 25 eu - external costs of transport. Technical report, European Environment Agency, 2003.
- [5] Jean-Francois Gleyze. Effets spatiaux et effets réseau dans l'évaluation d'indicateurs sur les noeuds d'u réseau d'infrastructure. In *Cybergeo : Revue européenne de géographie*, N°370, 03 Avril 2007, 2007.
- [6] Jean-François Gleyze. *La vulnérabilité structurelle des réseaux de transport dans un contexte de risques*. PhD thesis, Université Paris VII, 2005.
- [7] INSEE. Nomenclatures statistiques françaises des domaines économique et sociale et définition des concepts dans les enquêtes et études de l'insee, 2011.
- [8] Somsakun Maneerat. Evaluation de la vulnérabilité et de l'accessibilité des réseaux exposés aux risques naturels gravitaires rapides en montagne. Master's thesis, Master SIGAT, Université de Haute-Bretagne, Rennes 2., 2011.
- [9] Eric Mermet. *Aide à l'exploration des propriétés structurelles d'un réseau de transport. Conception d'un modèle pour l'analyse, la visualisation et l'exploration d'un réseau de transport*. PhD thesis, Université Paris-Est, Marne-la-Vallée, France, 2011.
- [10] Eric Mermet and Anne Ruas. Geographlab: a tool for exploring structural characteristics of transportation network. In *13th International Conference on Geographic Information Science (AGILE' 10) proceedings, 10-14 May, Guimareas, Portugal, 2010*.
- [11] Yves Mortureux. *Techniques de l'Ingénieur -Traité "L'entreprise industrielle"*, chapitre La sûreté de fonctionnement : méthodes pour maîtriser les risques - Ref. AG 4 670 - 17 p. 2001.
- [12] Bernard Roy. *Multiple Criteria Decision Analysis : State of the art surveys*, volume 78 of *International Series in Operations Research and Management Science*, chapter Paradigms and Challenges - chapter 1, pages 1–24. Springer, 2005.
- [13] Thomas Saaty. *The analytic hierarchy process*. McGraw Hill, New York, 1980.
- [14] Jean-Marc Tacnet. *Prise en compte de l'incertitude dans l'expertise des risques naturels en montagne par analyse multicritères et fusion d'information*. Phd thesis in environmental sciences and engineering, Ecole Nationale Supérieure des Mines (ENSMSE), Saint-Etienne, France, 2009.
- [15] Jean-Marc Tacnet, Mireille Batton-Hubert, and Jean Dezert. A two-step fusion process for multi-criteria decision applied to natural hazards in mountains. In *Belief 2010, Proceedings of International Workshop on the Theory of Belief Functions, Brest (France), 1-2 april 2010*, 2010.